

DOCUMENT RESUME

ED 441 648

RC 022 454

AUTHOR Bull, Steve; Sauter, Jerry; Harris, Kevan; Sumner, Bonnie; Jervis, Charles; Miller, Bob; Turner, Pat

TITLE From Shop to Shakespeare: Interdisciplinary Instruction at Auburn High School, Riner, Virginia.

PUB DATE 1999-11-14

NOTE 27p.; Paper presented at the Annual Conference of the National High School Association (5th, Monterey, CA, November 12-14, 1999).

PUB TYPE Reports - Descriptive (141) -- Speeches/Meeting Papers (150)

EDRS PRICE MF01/PC02 Plus Postage.

DESCRIPTORS Construction (Process); *Cooperative Learning; *Cooperative Planning; *Curriculum Development; Facility Improvement; Gardens; High Schools; *Interdisciplinary Approach; *Secondary School Curriculum; Small Schools; Student Projects; Teacher Collaboration

ABSTRACT

This paper provides an overview of the interdisciplinary program at Auburn High School, a small high school in Riner, Virginia, and describes a recent schoolwide project to construct an Elizabethan gazebo and Shakespeare garden. To develop interdisciplinary units, the teachers begin by brainstorming ideas, looking for overlapping content. The next step is the more formal process of planning the unit, considering whether it will be thematic or process-oriented, how it fits into each teacher's area, and what resources are needed. Student assessment is also planned at this time, followed by the final stage of deciding specifics about timing and each teacher's role. The advantages of the interdisciplinary model include development of students' higher order thinking skills, enrichment of intergenerational connections, full inclusion of special education students, use of multiple modalities and intelligences, incorporation of several academic standards in one project, and fostering of cooperative learning among teachers and students. A typical interdisciplinary unit is described from the student's perspective. During 1998-99, the students planned and constructed a timber-frame Tudor-style gazebo and planted an Elizabethan "bowknot" garden around it. The project included English, history, science, carpentry and cabinet making, horticulture, and drafting classes. The completed structure and gardens will be used as an outdoor classroom and as a location for a Renaissance Faire, receptions, and ceremonies. Appendices include plans for the gazebo and garden and guidelines for interdisciplinary projects. (SV)

From Shop to Shakespeare

Interdisciplinary Instruction at
Auburn High School
Riner, Virginia

Presented by

Steve Bull , Jerry Sauter, Kevan Harris, Bonnie Sumner,
Charles Jervis, Bob Miller, Pat Turner

The National High School Association
5th Annual Conference

Monterey, California
November 12-14, 1999

U.S. DEPARTMENT OF EDUCATION
Office of Educational Research and Improvement
EDUCATIONAL RESOURCES INFORMATION
CENTER (ERIC)

This document has been reproduced as
received from the person or organization
originating it.

Minor changes have been made to
improve reproduction quality.

• Points of view or opinions stated in this
document do not necessarily represent
official OERI position or policy.

"PERMISSION TO REPRODUCE THIS
MATERIAL HAS BEEN GRANTED BY

Charles K.
Jervis

TO THE EDUCATIONAL RESOURCES
INFORMATION CENTER (ERIC)."

BEST COPY AVAILABLE

Introduction

Steve:

Good afternoon. I am Steve Bull, Social Studies Teacher at Auburn High School in Riner, Virginia. Co- presenters today are

- Robert Miller, Principal
- Charles Jervis, Science teacher
- Bonnie Sumner, Language Arts teacher
- Jerry Sauter, Language Arts teacher
- Pat Turner, Language Arts teacher and
- Kevan Harris, vocational teacher and inspiration for our cover.

In our presentation, we will give an overview of our interdisciplinary program and rationale for it , demonstrate our most recent project on an Elizabethan Gazebo and Shakespeare Garden, and have a question and answer session for those who might wish to implement a similar program. Pat will begin by explaining what we do.

How Teacher Oriented

Pat:

I'd like to begin by describing for you what teachers actually do to develop units that are interdisciplinary in nature.

The first step is simply to brainstorm ideas, looking for overlapping content. For example, if American literature or history is looking for a way to approach teaching the early part of the twentieth century, one idea that could come up is to research the waves of immigration into the United States at this time. At this point each teacher looks for ways his or her subject could approach this topic. The literature person could look at pieces written by or about immigrants, while the history person looks at original source documents, the science person studies diseases brought over or caused by

living conditions at the time, while a math person considers teaching statistical analyses of various immigrant groups, etc. Critical to this phase is clarification of who will be teaching what aspect of the total content the students are to study.

The next step is the more formal process of developing the unit. An early decision has to be whether the unit is primarily going to be thematic or a process oriented unit such as persuasion/research documentation. If a field trip is to be incorporated into the unit, identify what is appropriate, how does it fit into each teacher's area, and who will make the arrangements? At this point, teachers also indicate resources they know are available in our media center, on the web, or personal items to which they have access and which all students may use.

This is also when student assessment is considered. Typically, a handout is developed for students which clearly states the types of assessment required and the criteria by which they will be judged. (You have a sample in your packet.) Since it is crucial that both teachers and students agree on criteria, we have gradually developed and refined a set of rubrics which are easily accessible for student viewing and which state what an "exceptional", "adequate" and "needs improvement" product looks like. The teachers also decide when the assessments are due and how much they are worth in each class. We have found it useful for teachers to grade projects jointly, and give dual or multiple credit in the various classes involved in the unit.

The final stage of planning is to decide the specifics of exactly when the unit will begin and end, who is taking the students to do library or computer lab research, when student groups will conference with a particular teacher, etc.

Once the unit is completed, an informal assessment is done by all teachers who participated. Teachers meet again and discuss the unit's success and decide on what changes, if any, are essential before using the unit again.

Now Jerry will briefly discuss why we have chosen to do this with our students.

Why Use This Approach

Jerry

One might ask, “Why go through all the trouble? Why make this effort to coordinate the instruction and assessment across the disciplines?” An illustration will describe why we have chosen to do things this way:

Several years ago, Steve and I were doing what we always had done, following a chronological approach to the subject matter. I was teaching a piece by John Smith when I had an epiphany. As the students were entering class and we were getting started for the day’s lesson, one student asked, “Is this John Smith we are studying in here the same one we are studying in history class?” (In eleventh grade American History and in American Literature we were studying the colonial period.) Suddenly it was clear that the parallel coverage which we thought was connecting the two courses wasn’t ! The connections which we thought were obvious were not being made, at least not by one student. We decided to be more intentional in showing the connections. We decided to take a more formal approach to this Interdisciplinary Instruction.

Initially it was the logical history/English team in which we changed the way we planned, instructed, and assessed. Over the past twelve years, however, the team has expanded to include science and vocational disciplines and grades 9-12.

Let me talk about some of the advantages of our interdisciplinary model. Standards notwithstanding, students need to develop the HOTS---Higher Order Thinking Skills. Teachers need to encourage the HOTS. Interdisciplinary instruction does both. It does so by reinforcing these skills in English, history, science, and technical education. It does this by enriching the HOTS through project based work which we do every grading period. It also enriches intergenerational connections for

our students.

One of our students worked on a World War II unit. One of the products she selected was an interview with her grandfather. Although he had never spoken of the war to her before, this time he was receptive to participating. This connection helped her synthesize the realities of war from a personal perspective. Additionally, we have found that Interdisciplinary Instruction helps increase the chance of success for varied students.

We have full inclusion of special education students in our school, and in these units of study, we see no difference between the products of students with disabilities and those identified as gifted. The student mentioned earlier had a special education IEP, yet her products were consistently exemplary.

Another advantage is that with Interdisciplinary Instruction we have been able to address multiple modalities and intelligences.

We are aware, as we are sure you are, of the Principles of Multiple Intelligences. We have modified this Principle to recognize Multiple Abilities, Modalities, and Standards. We recognize that students have strengths in different areas or different learning styles or preferences. We design the interdisciplinary instructional units so that opportunities exist for students to use many different techniques in their research. For example, we had a student who generally refused to write, respond, or engage in traditional assessments; yet, on a field trip to Monticello, he and a partner paced off the dimensions of the building, drew sketches, and made plans while there and came back and made a museum quality model of Jefferson's home. Performance inclined students have sung and played songs from the WW II era and the 1960's and performed dances from the 1850's and 1920's. All of these use communication skills. We have found that Interdisciplinary Instruction meets standards as well.

When we look at the various standards, we find that there is significant overlap with regard to implied or expressed skills which are required and that there is some overlap in content. We incorporate into the interdisciplinary instructional units standards from these overlapped areas. By providing students opportunities to address several standards from history and science at the national level and history, science, and English at the state level in one project, reinforcing standards becomes an added bonus.

We have standardized our cooperative learning group vocabulary and practices so that there is some uniformity which reinforces this practice across the disciplines. Finally, by using this approach we have found a more time efficient way to teach and learn. Students get multiple credits, so that there is less redundancy in their overarching content and process requirements. Instead of doing three or four projects in any grading period, they may do only one.

This also fosters cooperative learning among teachers and students. We divide grading using mutually agreed upon rubrics. We meet and discuss questionable performance or products. We reach consensus on quality of assessments and students get feedback from several teachers on the quality of their work at the same time.

Now, here's Charles to describe for you what it looks like from a student's point of view.

How- Student Oriented

Charles

Having seen what we do and why we do it, you may ask, "What do students see and do as they engage in this method of interdisciplinary instruction?"

We begin every Interdisciplinary Unit with a project introduction. In this we

present the general scope of the study (time period, skill, process or topic covered) and a list of product and research options (a sample is in in your handouts) for student study within a general framework. We always leave the option for student to add their own topic within the framework if they desire. For example, in a unit we do called the "Century Countdown" in which students study decade time frames and a variety of topics within the decade, we once had a student who was the son of an Elvis impersonator. Elvis was not on the list. So when he wanted to add an in depth study of the role of and influence by Elvis Presley in our 50's decade list, he did. He used his resources, which for that topic were extensive, to present his understanding of Elvis' impact on the 50's.

Students also have options of assessment products that they can select. We have a fluid list (a sample of which is also in the handouts) and students select from these to produce a portfolio which they use to show their understanding. As part of the assessment, individuals or groups do an oral presentation with defense in which they communicate their understanding to the whole class. They must be prepared to answer questions from the audience, which includes one or more teachers and their peers, as part of their oral presentation. For the portfolio they get group and individual grades. From this perspective, it should be evident that they work in Cooperative Learning Teams. Students self-select for these teams. Sometimes they realize during the year that their selections are not working, so the teams are fluid. Generally, once a project is begun, however, they do not change until next the project is assigned. Teams can include classmates from different sections of the course as well as members of the same section. It is also possible, from time to time, that different grade levels are included.

With the teams in place and with the teachers' help, students identify shared resources they have which are necessary for project completion. A division of labor

usually follows and resources such as their library materials, community contacts, technology or personal materials are selected, sorted and evaluated. Product formats are identified by the group and roles for completion are designated. These are most often done with minimal teacher input. Students are referred to the rubrics, which we keep public, so that they know the performance criteria and expectations for success. Benchmark products are available so students have concrete models to follow, and we hope, exceed.

When we reach consensus on a "grade," we return the products with feedback on what improvements, if any, are needed. Revised products are returned to us and final assessments are made and grades recorded.

Now to describe a recent school wide multiple grade level unit of study, here are Bonnie Sumner and Mr. Miller.

Bonnie and Bob:

In 1995, while our vocational students participated in job-shadowing opportunities with local industries, we visited Blue Ridge Timberwrights, a timber frame manufacturer and builder. Subsequently, several of our students became employees, one rising to lead joiner. After seeing the quality and design of structures erected by Blue Ridge, we began to dream of a timber frame structure for our community.

In the spring of 1998, a group of teachers at Auburn High School applied for two grants to assist with development of a Shakespeare Garden project. Both grants were awarded--one a STAR grant from Montgomery County Public Schools in the amount of \$1000, and the other a Virginia Commission of the Arts grant for \$300. These funds were used to purchase reference materials, garden tools, and plants for the garden, as well as for teacher training. Simultaneously, Blue Ridge Timberwrights offered to assist our students in crafting a timber frame structure, and the principal and carpentry teacher agreed on a gazebo for the garden, both to serve as a centerpiece of the

garden and as a memorial to deceased classmates.

Because of its connection to the Elizabethan garden, we chose a design based on the appropriate English Tudor period style. Our students visited Agecroft, a relocated and restored English manor house in Richmond, Virginia, where they observed and studied garden designs and timbered garden dependencies. Our gazebo was built from 8 x 8 inch posts and beams with mortise-and-tenon joinery, drawn together using one inch oak trunnions. The roof uses a trunnelled kingpin truss system. In lay terms, that means that no nails were used to hold the structure together, and that all timbers fit tightly at intersecting joints. The timbers came from both likely and unpredictable sources---a demolished local warehouse, a structure in Boston, and from the Saint Lawrence Seaway where they had served a docking materials.

The objectives of this interdisciplinary project include:

- to identify plants in the writings of William Shakespeare, research their significance in Elizabethan society, and research the scientific names and habitats of these plants
- to collect and analyze soil samples from the proposed garden site
- to research garden designs common to 16th century England
- to use computer programs and research findings to design the Auburn Shakespeare Garden
- to use computer assisted design (CAD) and conventional drafting and construction methods to design and build a gazebo using the timber frame technique
- to enhance the beauty of Auburn High School grounds
- to give students an opportunity to have ownership in their physical environment at school
- to write and publish a literary garden guide and history of the garden/gazebo project

These objectives address numerous State Standards of Learning in several curricular areas:

- Science- botany / horticulture / soil analysis / ethnobotany
- History - religion (maze) / medicinal herbs / formal gardens / plague (tussy mussy)
- Landscape- Art / Architecture
- Math - drafting and design
- Tech ed- construction
- English - Shakespeare

Drawings for the gazebo were developed by students in our drafting classes; in your handouts, you can see both original pencil drawings and computer assisted (CAD) plans. The style, roof pitch and structure of our original 1938 building was matched in the design details of the projec. After several consultations with the timber wrights and our students, we prefabricated the building in two Saturday sessions, training students to do the intricate cuts and joinery required. Some students sanded and prefinished the posts and beams, while other students, staff, and community volunteers poured the concrete foundations and floor, and laid the brickwork.

On Friday, May 14, a ceremonial raising of the structure was held, involving most of the 80 to 100 students and 12 staff members along with community volunteers. The six businesses who assisted with donations of goods and services were recognized. Still remaining to be completed are the brick floor and benches, along with a plaque designating contributors. When complete, the gazebo will serve as a location for class meetings, relaxation, or social events.

The monetary value of the Auburn Memorial Gazebo and Garden Project is approximately \$15, 000, but the value to the school and larger community today and in the future is harder to compute. Assessing the value of this cooperative venture for the students who say with pride "I helped build that, "and who learned how to problem-solve as they did something significantly constructive can only be measured in a lifetime. It is our hope that this project will help students to develop skills that last a

lifetime.

The administration and faculty of Auburn have embraced interdisciplinary learning for ten years, and view "From Shop to Shakespeare" as a project which includes English, history, science, carpentry and cabinet making, horticulture, and drafting classes. In addition to the interdisciplinary nature of the project, it is a continuing process of researching, planting, and maintaining the garden and building, therefore, it will continue to cross curricular boundaries as long as the school exists.

Except for plants and gardening materials and tools, no funds were expended for the garden and gazebo. The project generated support and donations from the business and private sector of the community. Many businesses, including Marshall Concrete, Reed Lumber Company, New River Concrete, Old Virginia Brick, Eastern Repair and Fabrication, and Sisson and Ryan Quarries donated materials. Employees of Blue Ridge Timberwrights donated time in their facility helping students prepare the donated timbers and were present at construction of the gazebo. Individuals in the community have donated plants and garden ornaments.

Our horticulture class has planted spring bulbs (daffodils, jonquils, crocus, iris) appropriate for the period, and Old English Roses and English boxwood have been installed in the geometric shapes characteristic of an Elizabethan "bowknot" garden. The completed structure and gardens will be used as an outdoor classroom, as a location for a Renaissance Faire, and a place for receptions and recognitions at special times.

This ongoing project is a source of pride for students and faculty at Auburn High School, and is a visible sign to the public of the high quality work that a diverse student population has created and will maintain.

Closing and Q & A

Steve: Other Projects

Future of Gazebo

Renaissance Fair

Dramas

Creative Writing

Horticulture

Thoreau Project

HANDOUTS

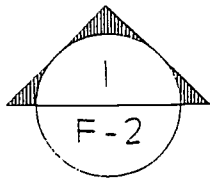
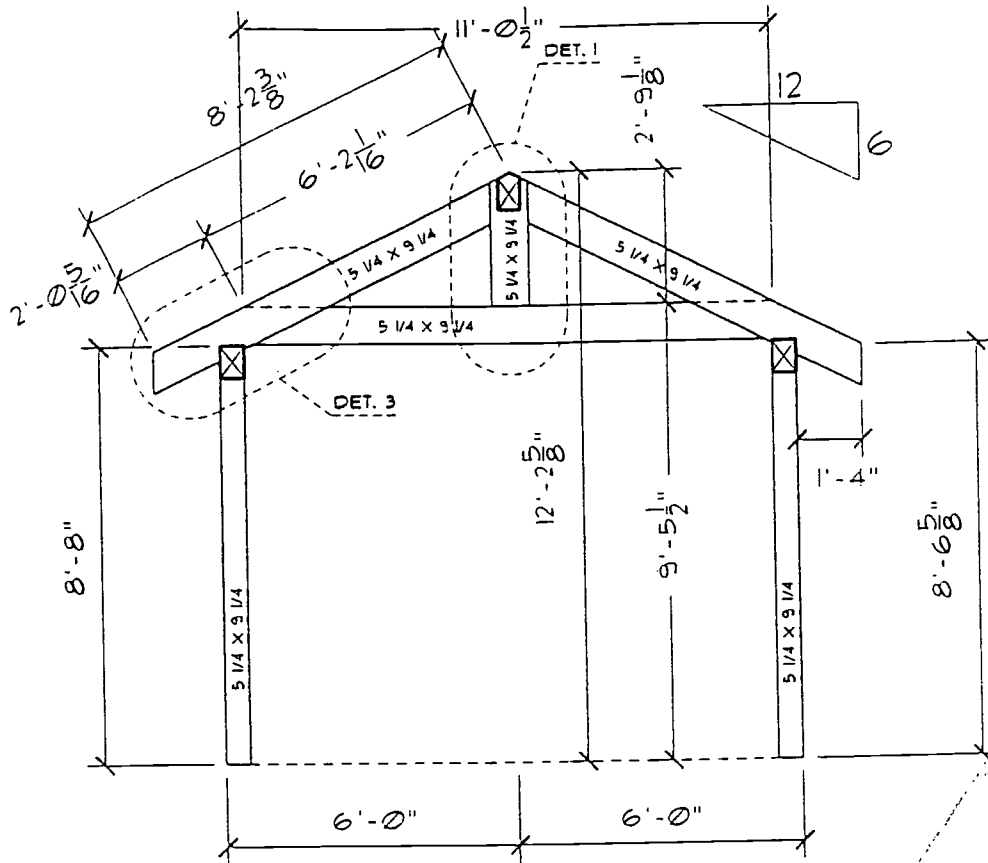

BENT - 2

SCALE: 1/4" = 1'-0"

ALL BRACES ARE CENTERED

VIEWED FROM CE

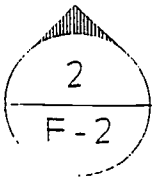
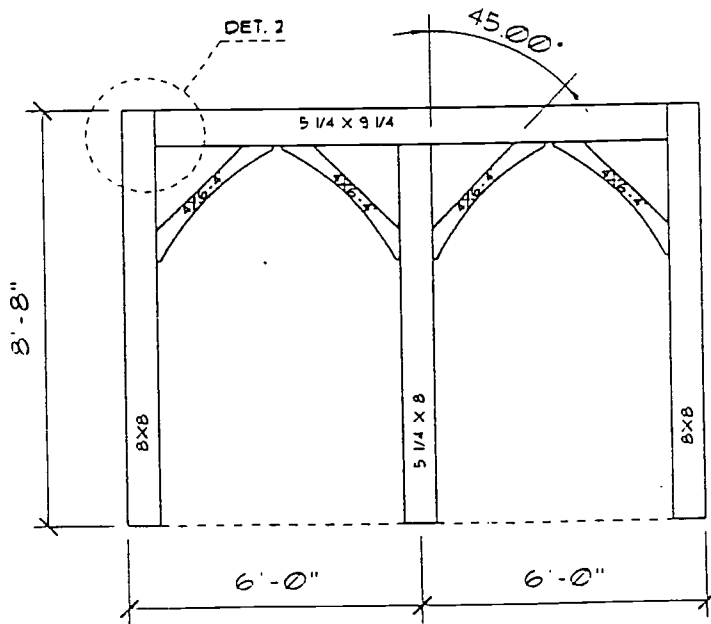

BENT - 1

SCALE: 1/4" = 1'-0"

ALL BRACES ARE CENTERED

VIEWED FROM CE

CLIENT	AUBURN H.S
JOB #	0227
DATE	03.21.99
DRAWN	NA
CHECK	
SCALE	1/4" = 1'-0"

*Interdisciplinary Teamed Instruction:
The Journey Continues ...*

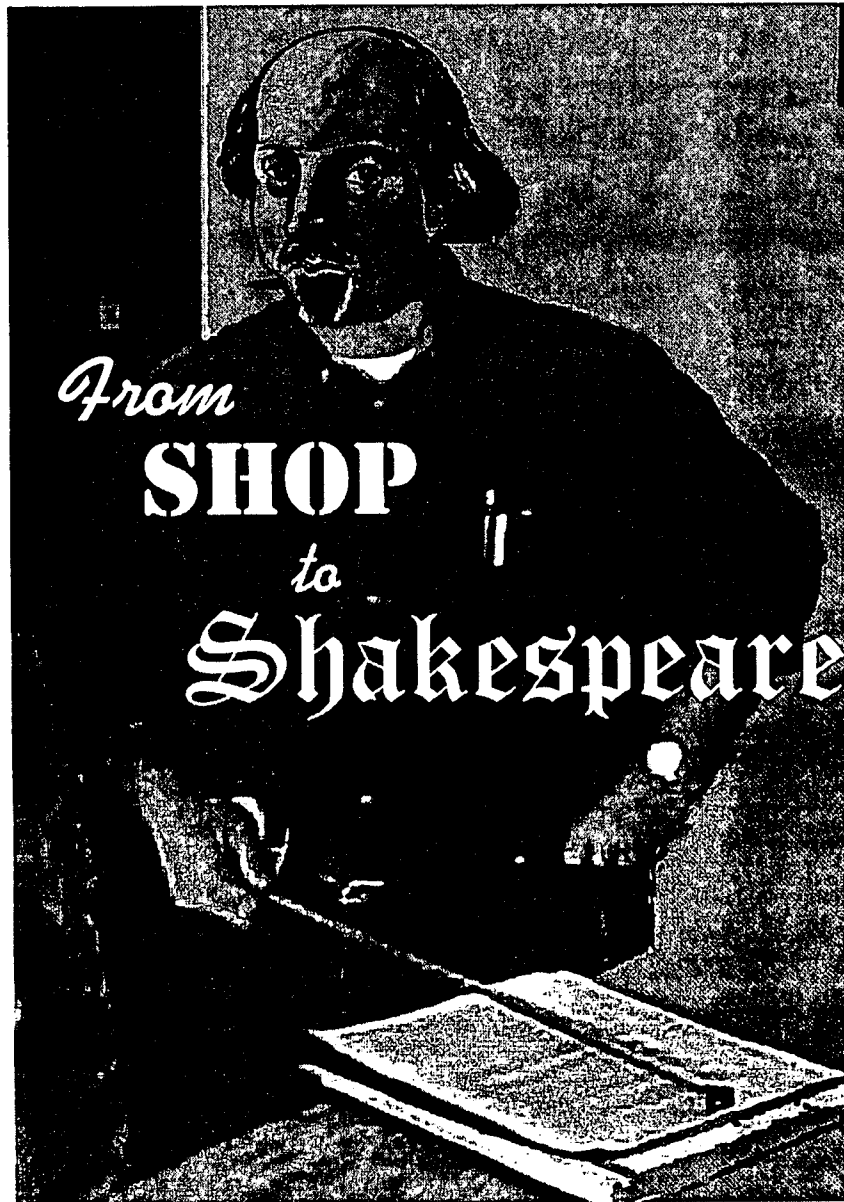

Auburn High School

Riner, Virginia

Steve Bull

Jerry Sauter

Kevan L. Harris

Bonnie Sumner

Charles Jeruis

BEST COPY AVAILABLE

Pat Turner

Bob Miller

What - Teacher Oriented

- Interdisciplinary Planning
 - Brainstorm Ideas
 - Identify Overlaps
 - Divide Content
- Unit Development
 - Thematic/Process
 - Field Trip Coordination
 - Resource Sharing
- Assessment
 - Types
 - Criteria
 - Rubrics
 - Credits
- Divide Content

Why - Teacher and Student Oriented

- Enhance/Enrich/Reinforce - HOTS
- Multiple
 - Abilities
 - Modalities
 - Intelligences
 - Standards
- Foster Cooperative Learning
- Time Efficiency

How - Student Oriented

- Project Introduction
- Cooperative Learning Teams
- Shared Resources
- Alternative Assessments
- Common Rubrics
- Multiple Revisions
- Oral Presentations and Defenses
- Multiple Grade Levels

Example - Gazebo Project

History

Overlapping disciplines

Science - botany/horticulture/soil analysis/ethnobotany

History - religion (maze)/medicinal herbs/formal gardens/
plague (tussy mussy)

Art - landscape art/architecture

Math - drafting/design

Tech Ed. - construction (tools/techniques)

English - Shakespeare/Elizabethan Age

Construction (Slide Show)

Closing and Q & A

Other Projects

Future of Gazebo

Renaissance Faire

Dramas

Creative Writing

Horticulture

Thoreau Project

INTERDISCIPLINARY UNITS

	IMPLEMENTATION STRATEGIES									
	Pairs of Teachers	Small Groups of Students	Grade Specific	Cross Content	School Wide	Small Teams of Teachers	Blocked Time	Cross Grade	Content Oriented	Process Oriented
Immigration			*	*			*		*	*
Technology Assessment	*	*		*				*	*	*
Contemporary Issues	*			*		*		*	*	*
Shakespeare	*		*	*		*			*	*
World's Fair				*	*			*	*	*
20th Century Countdown				*	*			*	*	*
Mythology	*		*	*		*	*		*	*
Election			*	*	*		*	*	*	*
Reform Movements	*	*	*	*		*			*	*
Appalachian Heritage	*	*	*	*		*			*	*

Garden Plan

Diagram your 2000 garden plan. Include specifically: which types of plants you plan to grow, where they will be planted, and any special features such as container plantings, weather stations, wildlife habitats, etc.

Note: 1 box = 3 square feet (fill in the blank)

AUBURN HIGH
SHAKESPEARE
GARDEN PLAN

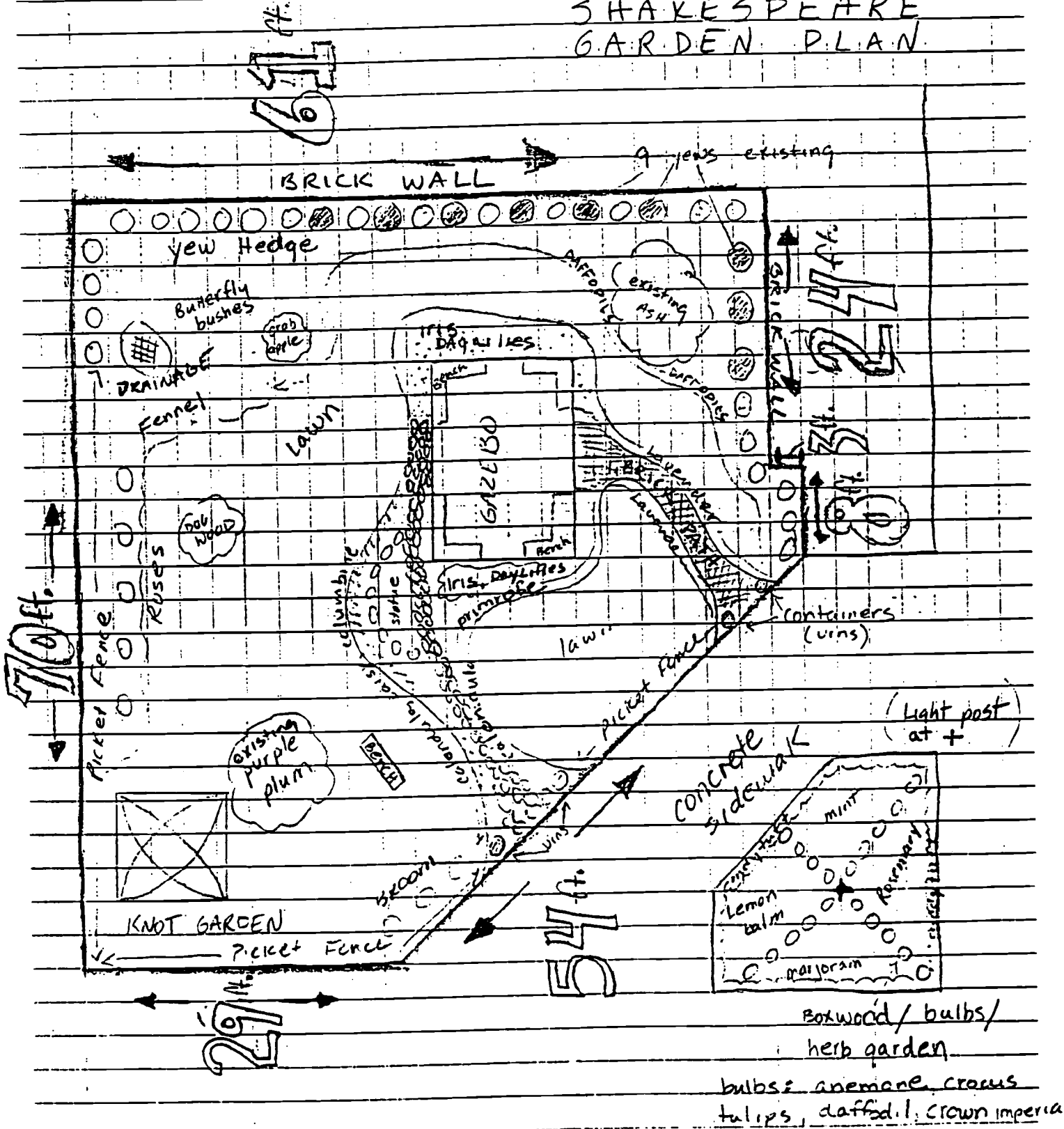

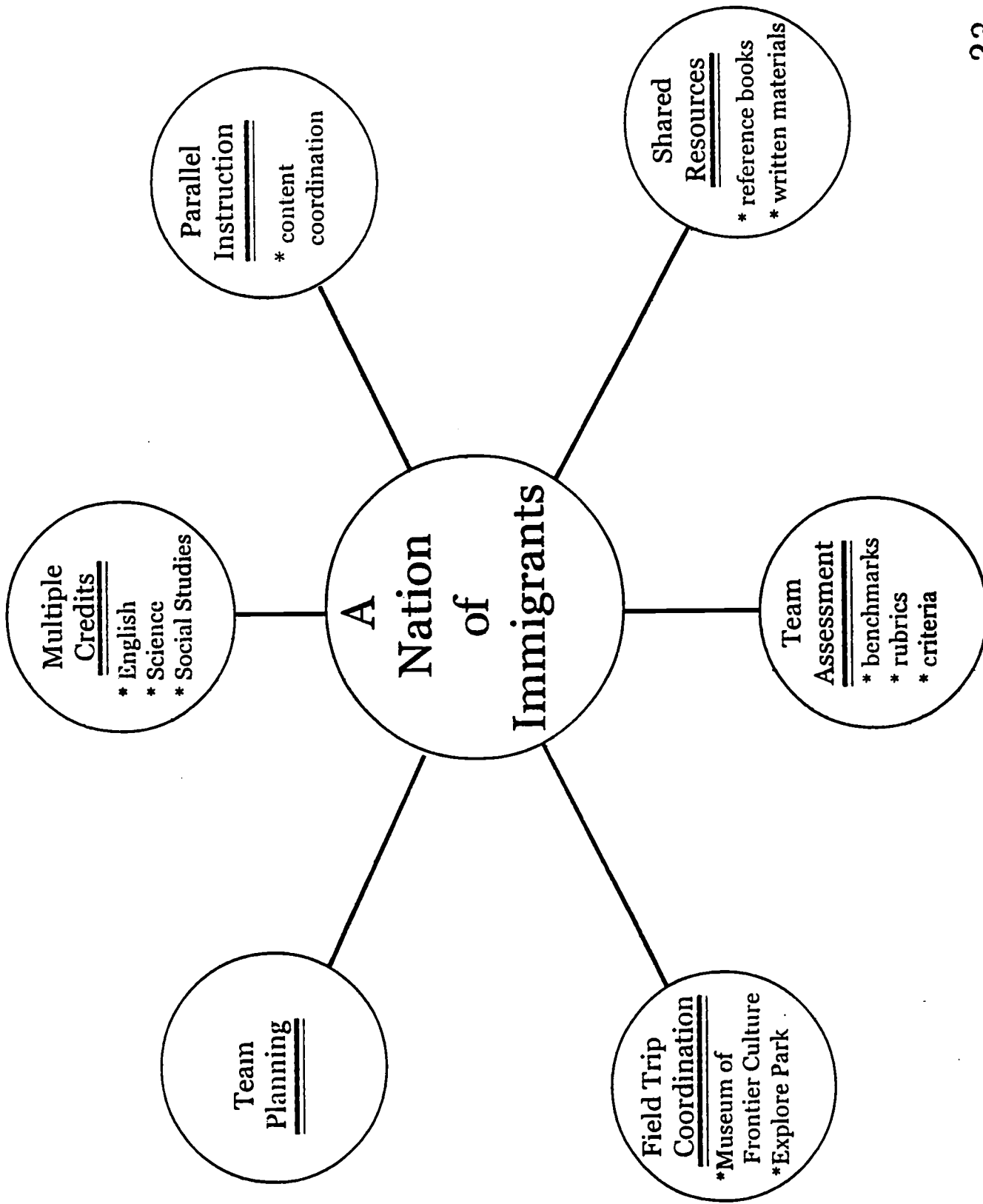

Unit 1 - A Nation of Immigrants

The United States is truly a nation of immigrants. Each citizen of our country is an immigrant or descended from an immigrant. To better appreciate our rich culture, students will complete a portfolio of assignments related to some aspect of the immigrant experience. Each portfolio will include three products and/or performances from the following list. Students may work in groups of no more than three or as individuals. Combination of products is encouraged. The completed portfolio is due September 27, 1999.

Product options:

- Brochure
- Chart
- Collage (no xerox)
- Commemorative Stamp
- Diary / letters to or from home
- Diorama
- Display
- Film analysis
- Graph
- Illustrated Timeline
- Interview
- Model
- Newspaper account
- Period costume
- Personal Effects
- Poetry
- Propaganda Tool
- Radio Account
- Response journal- at least three times per week record what you have learned about the period in relation to English, History, or Science. Respond to what you have learned by making inferences, hypothesis, or stating personal opinion.
- Scrapbook
- Survey/poll
- Table
- Videotape of performances

Performance options:

- Role Play Skit
- Monologue
- Music of immigrant group performed by student.
- One Act Play
- Speech

General Guidelines for Project Completion

1. Consult the rubrics for each product.
2. Revise the products.

3. The group members will orally present the findings/results of their study. ALL group members must demonstrate a basic competency with the facts, concepts and applications of their topic(s).
4. You will receive a group and an individual assessment.
5. Use of primary source documents is encouraged.

Project Topics:

1. Make up questions and interview a naturalized citizen.
2. Trace the geneology of your family tree and national origin.
3. Show immigrant contributions to/influences on the U.S.
4. Explain immigration patterns.
5. Describe how the diet changed as a result of the interaction between the Old World and the New World.
6. Explain the use of technology by specific Native American tribes/regions.
7. Describe the treatment of specific immigrant groups.
8. Discuss the problems encountered by Japanese-Americans during WWII.
9. Show the effect of the European explorers/colonists on Native American populations.
10. Demonstrate the influence of Spanish architecture in the Americas.
11. Draw or construct a display of various Native American artifacts.
12. Make or illustrate Native American or Colonial costume.
13. Report on the social, spiritual, and cultural aspects of a Native American tribe.
14. Discuss or illustrate Native American and/or Colonial uses of medicines, herbs, or chemistry.
15. Describe the Triangle Trade.
16. Describe culturally specific practices in conflict with U.S. views (e.g female mutilation).
17. Describe the varying role of women in specific ethnic groups.
18. What are the reasons for settling in a specific geographical area?
19. Describe changes in immigrant laws from 1880 to present.
20. Describe the impact of scientific discoveries and technological development on immigration.
21. Describe the various cultural uses and attitudes towards natural resources.
22. Assess the historical accuracy of a film dealing with the immigrant experience.
23. Research specific rituals/beliefs of a cultural group.
24. Pirates of the Caribbean
25. A day in the life of an immigrant.
26. The Scotch-Irish in Appalachia
27. Any other topic approved by Mr. Bull, Mr. Hurd, Mr. Jervis or Mr. Sauter.

BROCHURE

It must be computer generated. A clear theme must be evident throughout the brochure. Unity of the sections should be demonstrable. Scanned graphics and photographs should be used and should be student originals where applicable. Text and graphics must be balanced with minimum trapped space. There should be no pasted material in the product. Unique and appropriate paper stock should be used. The brochure should be free of mechanical and grammatical errors. The audience should be considered and addressed throughout. The work communicates well with the intended audience.

EXPERT LEVEL: of achievement will meet or exceed all the criteria above.

ACCEPTABLE LEVEL: Meets above criteria but weaknesses are apparent in unity, analysis or communication.

NEEDS REVISION : Product is weak in several of the areas and suggested revisions need to be made in the time period stated.

NO CREDIT achievement will be earned for anything less than the above.

BEST COPY AVAILABLE

Designed by Auburn High School ITI Team

DIARY

The diary shows a progression of unifying events or themes. All entries are historically accurate and cover a realistic time frame for the events to unfold. The entries contain descriptive details and use language and style which would be appropriate for the author and the time period. Each entry contributes in developing the unifying theme. Entries are grammatically and mechanically appropriate.

EXPERT LEVEL: of achievement will meet or exceed all the criteria above.

ACCEPTABLE LEVEL: Meets above criteria but weaknesses are apparent in unity, analysis or communication.

NEEDS REVISION : Product is weak in several of the areas and suggested revisions need to be made in the time period stated.

NO CREDIT achievement will be earned for anything less than the above .

Designed by Auburn High School ITI Team



U.S. Department of Education
Office of Educational Research and Improvement (OERI)
National Library of Education (NLE)
Educational Resources Information Center (ERIC)



NOTICE

Reproduction Basis



This document is covered by a signed "Reproduction Release (Blanket)" form (on file within the ERIC system), encompassing all or classes of documents from its source organization and, therefore, does not require a "Specific Document" Release form.



This document is Federally-funded, or carries its own permission to reproduce, or is otherwise in the public domain and, therefore, may be reproduced by ERIC without a signed Reproduction Release form (either "Specific Document" or "Blanket").

EFF-089 (3/2000)